

Lichtlauf

## product description

enclosed

Design Christoph Matthias 2009

Aluminium, glass, ceramics. A halogen lamp with reflector illuminates walls or objects. Ceiling-mounted, 180° rotatable.

Halogen bulb 230/125 V max. 75 W, PAR 30°. Lampholder E 27 ceramic.

Including surface-mounting box. Can also be mounted on the wall.

Dimensions approx. 8.5 x 16 cm.

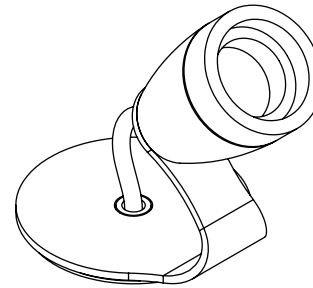

Spotzki

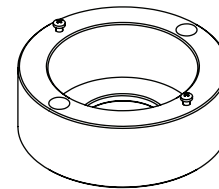

Surface box with screws

## technical data

230V ~ 50Hz

1x max. 70 W, E27



Type:

Indoor light IP20

This luminaire is suitable for illuminants of the energy classes: E - A++  
The luminaire is sold with a light source of the energy class: D

## safety note

Follow always the hints of this instruction for a safe assembly and use of these lights. Keep the assembly instruction for further questions.

The assembly and the electric supply must be done by an electric professional. Local installation regulations have to be respected.

The manufacturer accepts no liability for any damage due to improper use of the luminaire.

**Attention! Before working on the luminaire disconnect it from the mains. Also for cleaning, maintenance and lamp change.**

Luminaires are only allowed to be used for the specified purpose. Interior lights may not be used in outside area. Luminaires may not be covered.

They may not be connected to power supply still they are packaged.

Lights with electronic control gears (ECG) have to be operated with original ECGs.

The lamp change must be done by a competent professional.

Use only lamps with same type of construction, performance and voltage.

In case of damages, in particular of cable and socket, the luminaire have to be shut off immediately. In case of damage on the mains cable it has to be changed by the Lichtlauf GmbH.

For malfunction call authorized personnel for troubleshooting.

Never repair it by yourself.

Through improper repair work may arise risk for the user.

Elements of plug and connection shall be free from traction and torque.

## care instructions

Disconnect the device from the power supply grid before cleaning.

The care of lighting is limited to the surfaces.

Make sure that no liquid can reach the connection area or electrical components.

### **Important:**

Please don't use spiritus or alcohol containing products.

**As well as no abrasives or abrasive containing detergents.**

Only use a damp cloth to clean the lamp.

## special notes

Keep plastic bags and small components away from children to avoid risks of suffocation or swallowing!

## Mounting on flush-mounted box

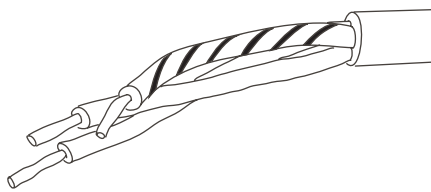

Before you start mounting and connecting the luminaire, make sure that the supply cable is disconnected from the mains! Remove the fuse!

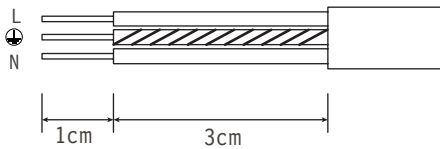

Prepare the cables at the cable outlet as shown in the figure.

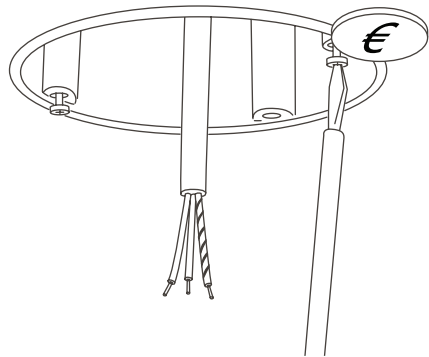

To set the correct distance between the screws on the flush-mounted box, it is best to use a 1 € piece as an orientation dimension.

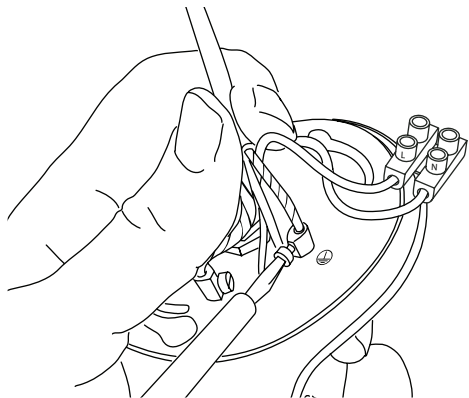

Connect the protective conductor to the Ground connection on the rotary plate.

Connect as on the luster terminal described the N and L lines.

Before installing the mounting plate, please note the desired orientation of the luminaire. Guide the mounting plate onto the screw heads of the flush-mounted box and turn it clockwise until the screws lock in place and the base plate no longer comes loose during rotation.

Do not pinch the cables!

Make sure that the screws are tight, if necessary tighten them a little after removing the base plate.

If the whole thing is too wobbly or cannot be turned at all, check the screws and loosen or tighten them.

To remove the baseplate, turn counterclockwise with a firm jerk. Please make sure that you do not overwind the integrated rotation limitation!

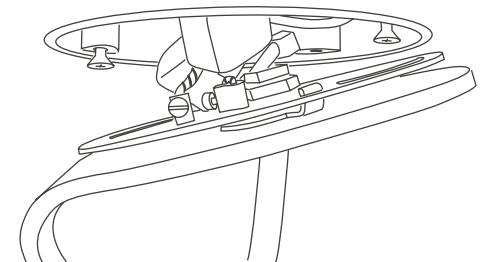
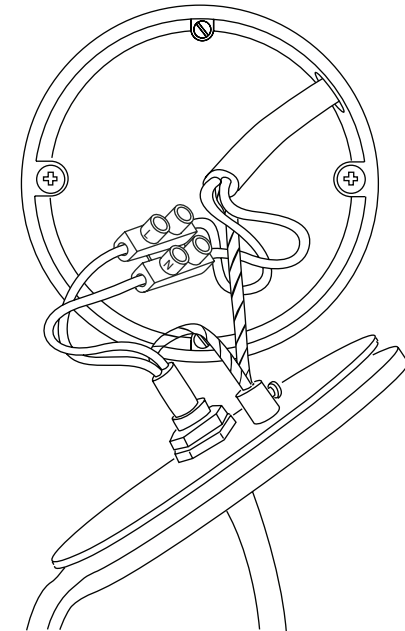

## Mounting without flush-mounted box

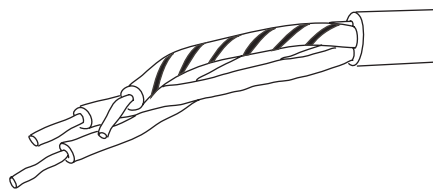

Before you start mounting and connecting the luminaire, make sure that the supply cable is disconnected from the mains! Remove the fuse!

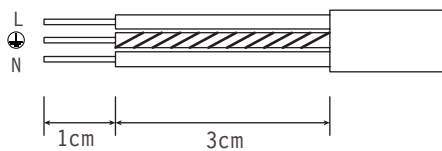

Prepare the cables at the cable outlet as shown in the figure.

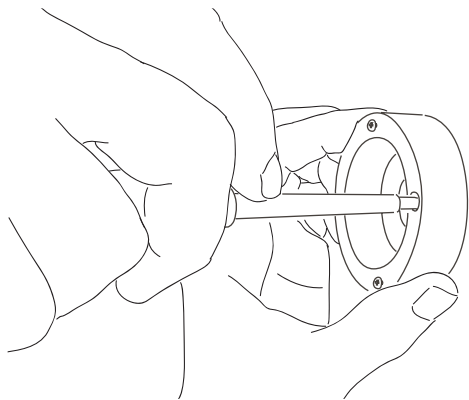

Then fix the enclosed surface box with adequate material (dowels, screws). When drilling, make sure that no cables are damaged.

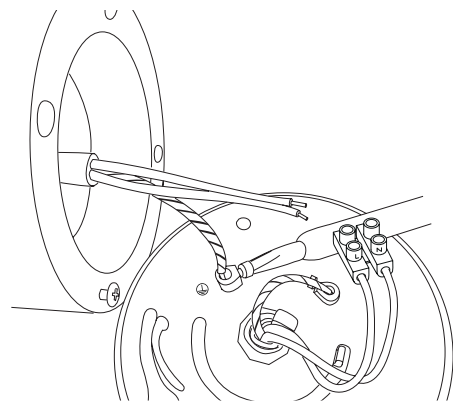

Connect the protective conductor to the Ground connection on the rotary plate.

Connect as on the luminaire terminal described the N and L lines.

Before installing the mounting plate, please note the desired orientation of the luminaire. Guide the mounting plate onto the screw heads of the flush-mounted box and turn it clockwise until the screws lock in place and the base plate no longer comes loose during rotation.

Do not pinch the cables!

Make sure that the screws are tight, if necessary tighten them a little after removing the base plate.

If the whole thing is too wobbly or cannot be turned at all, check the screws and loosen or tighten them.

To remove the baseplate, turn counterclockwise with a firm jerk. Please make sure that you do not overwind the integrated rotation limitation!

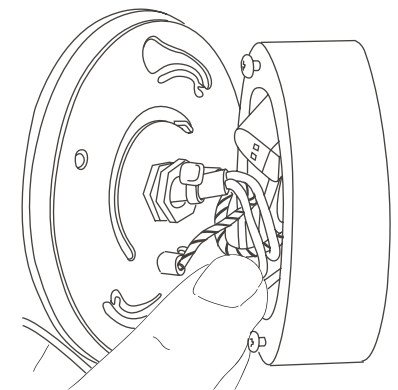
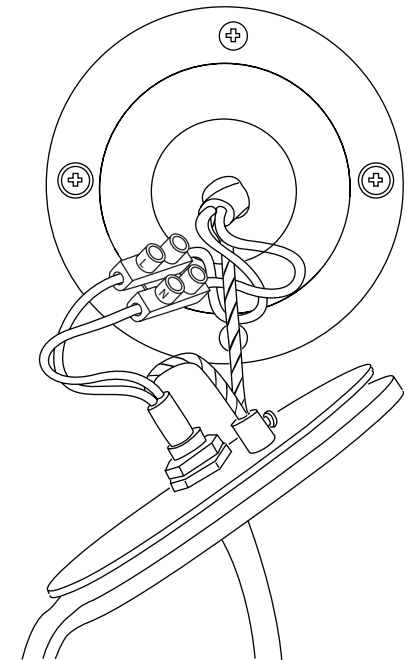



**Lichtlauf GmbH**

Sonnentaustraße 12  
80995 München

T +49(0)89.30905274-0  
F +49(0)89.30905274-9

[info@lichtlauf.de](mailto:info@lichtlauf.de)  
[www.lichtlauf.de](http://www.lichtlauf.de)